

stern

STERN ENGINEERING LTD.

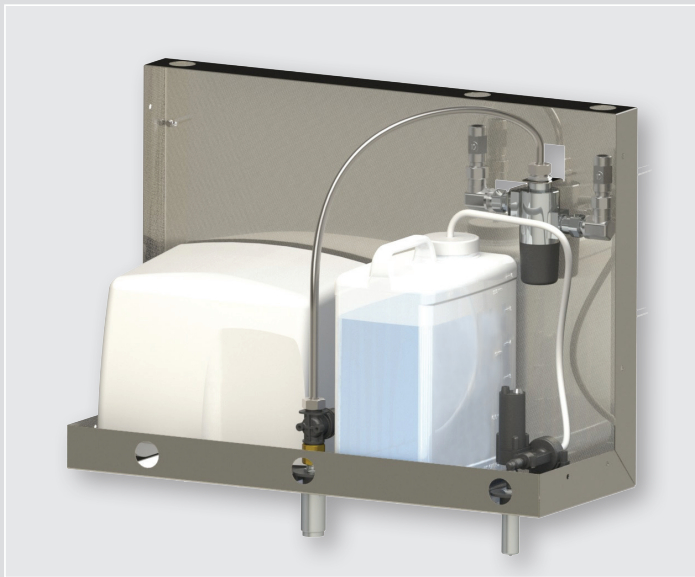

SOAP WATER AIR MODULE

INSTALLATION AND MAINTENANCE GUIDE

INDEX

1	ABOUT THE SWA SYSTEM
1	PRE-INSTALLATION
2	PACK CONTENTS
3	TECHNICAL DATA
4 - 6	INSTALLATION
7	FILLING THE SOAP TANK
8-9	MAINTENANCE
10	SPARE PARTS
11-13	REMOTE CONTROL FUNCTIONS - FAUCET
14	REMOTE CONTROL FUNCTIONS - SOAP DISPENSER
15	LIMITED WARRANTY
16	TROUBLESHOOTING - FAUCET
17	TROUBLESHOOTING - SOAP DISPENSER

The information in this document reflects products at the date of printing. Stern Engineering Ltd reserves the right, subject to all applicable laws, at any time, at its sole discretion, and without notice, to discontinue or change the features, designs, materials and other specifications of its products, and to either permanently or temporarily withdraw any of the foregoing from the market. All information in this document is provided "as is" without warranty of any kind, either expressed or implied, including but not limited to any implied warranties of merchantability, fitness for a particular purpose, or non-infringement. Stern Engineering Ltd assumes no responsibility for errors or omissions in the information presented in this document. In no event shall Stern Engineering Ltd be liable for any special, incidental, indirect or consequential damages of any kind, or any damages whatsoever arising out of or in connection with the use or performance of this information. The tradenames, trademarks, logos and service marks presented in this document, including their design, are the property of Stern Engineering Ltd or other third parties and you are not permitted to use them without the prior written consent of Stern Engineering Ltd or such third party as may own them.

ABOUT THE SWA SYSTEM

The Soap, Water and Air Module (SWA) is a modular, wall mounted, All-in-One system, that combines all three hand washing activities – Soaping, Rinsing and Drying – into a single integrated unit.

Available with or without the Air Dryer, with or without the Thermostatic Mixing Valve. Uses cold or premixed water.

Independent, touch free, infrared sensor activation for each functionality. Installation on brick walls, drywall, or wood frame constructions.

The SWA is available in 4 different configurations, as follows:

Air	Water	Soap
No	Cold	Yes
Yes	Cold	Yes
No	Thermostatic	Yes
Yes	Thermostatic	Yes

PRE-INSTALLATION



Notes & Cautions

- Before installing the system, please fully read and understand this document, and verify the package content.
- It is the installer's responsibility to comply with relevant local codes and regulations.
- Flush thoroughly the water supply lines before installing the SWA. Do not allow dirt, Teflon tape or metal particles to enter the faucet. Shut off water supply when done.
- Water and electrical supplies should be kept OFF throughout the entire installation.



Warning

Electrical voltage - Electric shock

Work on electrical installations may only be carried out by certified electricians or by instructed persons working under the guidance and supervision of a certified electrician, in accordance with local regulations.



Cautions

- To avoid reflection problems, keep a distance of more than 300mm between sensors and the surface below them.
- This SWA model, with its infrared sensor pointing down, is not intended to be used together with a sink of a reflective material such as stainless steel.
- If a sink strainer is straight below the faucet sensor, use a strainer with a non-reflective finish (do not use a chrome plated one).

PACK CONTENTS

SWA SYSTEM (Transformer included)

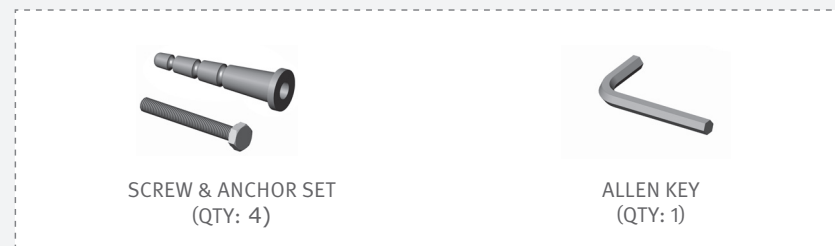
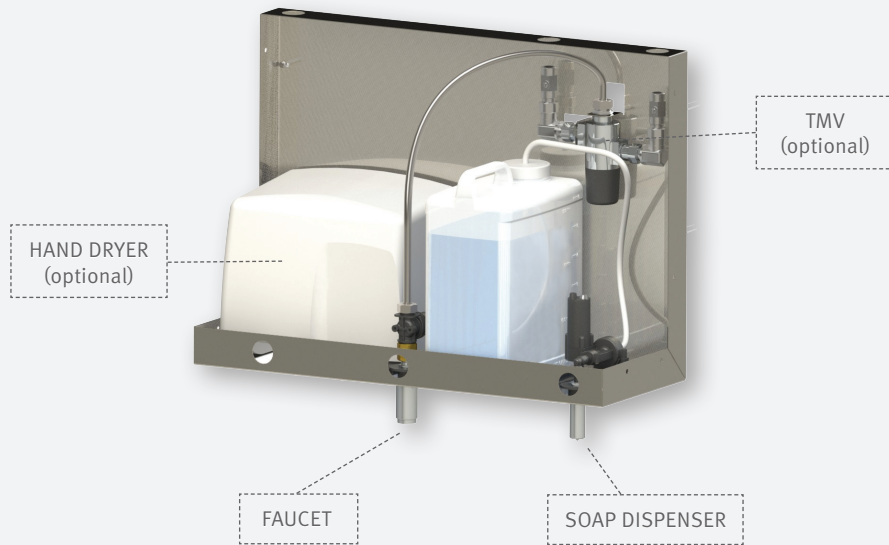

The SWA System can be ordered with or without the Hand Dryer and with or without the Thermostatic mixing valve *

TECHNICAL DATA

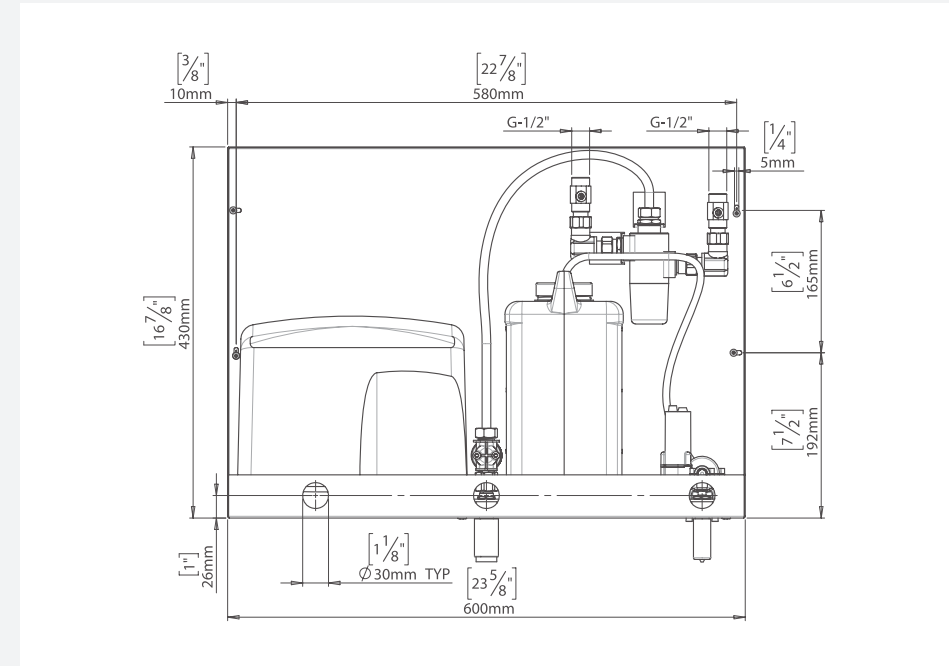

SPECIFICATIONS

Power supply	12V Transformer for faucet and soap dispenser
Recommended water pressure	0.5-8.0 bar (7-116 PSI) With water pressure of more than 8 bars, use a pressure reducing valve
Sensor range faucet	Self adjusting sensor. Adjustable with remote control Min: 80mm; Max: 300mm
Sensor range soap dispenser	30-100 mm +/- 10 mm (Adjustable by remote control)
Soap capacity	6 Liter \ 1.6 Gallon
Soap viscosity	100 - 3800 CPS
Standard soap discharge	0.8cc, Adjustable
Security time (faucet)	90 seconds. Can be reduced with the remote control
Hot water temperature	Max. 70°C
Code Number	280400

INSTALLATION

STEP 1 – WALL MOUNTING

Use the 4 Screws and Anchors to mount the SWA System onto its designated position through holes A1, A2, A3, A4.

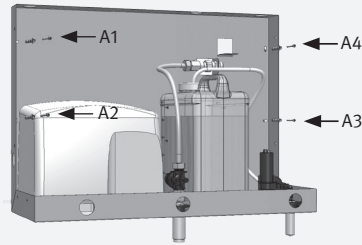

STEP 2 – CONNECT THE WATER SYSTEM

Before connecting the water system, close the SWA's water shut-off valves. Re-open these valves only when SWA installation has been completed.

Connect the water system to the SWA.

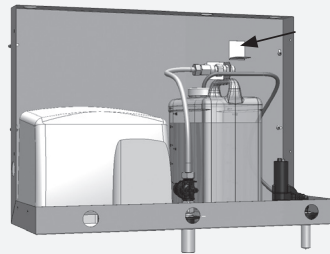

For SWA without a Thermostatic Mixing Valve, use either one of the B1 or B2 holes to connect the water system to the SWA.

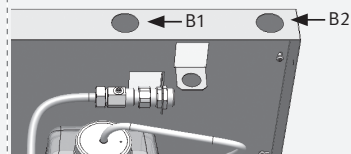

For SWA with a Thermostatic Mixing Valve, use hole B1 to connect the HOT water and hole B2 for the COLD water.

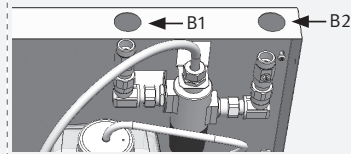

Notes:

Thoroughly flush the water supply lines before connecting them to the SWA. Do not allow dirt, Teflon tape or metal particles to enter the faucet. Shut off water supply when done.

IMPORTANT: Water and electrical supplies should be kept OFF throughout the entire installation.

INSTALLATION

If you acquired the SWA system with the hand dryer, follow the below instructions for powering it.

STEP 3 – POWERING THE HAND DRYER



Warning

Warning: Work on electrical installations may only be carried out by certified electricians or by instructed persons working under the guidance and supervision of a certified electrician, in accordance with local regulations.



Important Note: SWA is available only as either a 110 volt model or a 220 volt model. There is no 110/220 model

To power the hand dryer, a certified electrician must remove the dryer unit cover and hardwire it to the main power line.

To remove the dryer unit cover, remove the two Allen screws with the included Allen key.

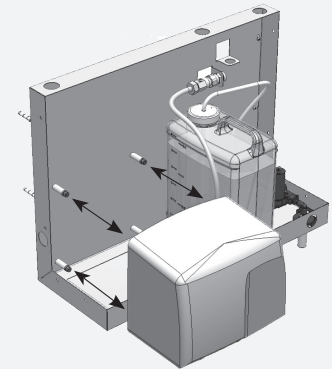

INSTALLATION

STEP 4 – POWERING THE SYSTEM

⚠ Important Note: The SWA's Faucet and Soap Dispenser each include a self-adjusting sensor. The ideal sensor range for the specific location will be set automatically.

Before proceeding, check that there are no foreign objects in front of the sensors

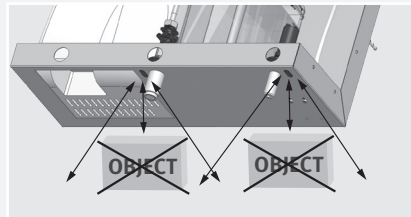

1

Remove the protective stickers that cover the sensors, both on the Faucet and on the Soap Dispenser. Re-open the water shut-off valves.

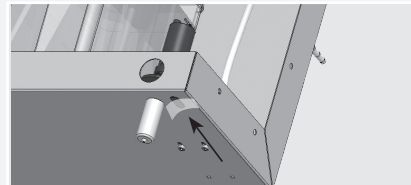

2

To power the faucet and the soap dispenser, run the end of the transformer cord through hole B3 (top left), then connect it to the power splitter. Plug the transformer into the main power line.

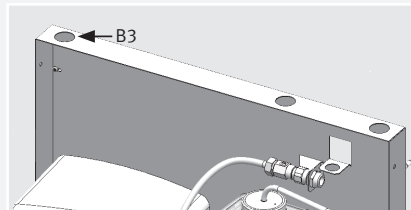

3

Wait about 10 seconds for the Faucet and the Soap Dispenser sensors to complete their self-adjustment.



4

Put your hands under the Faucet and the Soap Dispenser and verify their functionality.

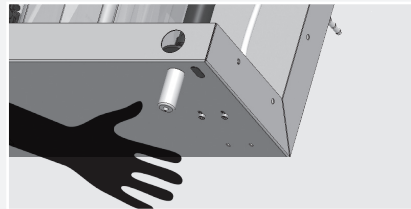

FILLING THE SOAP TANK

STEP 5– FILLING THE SOAP TANK

1

Unscrew the cover of the soap bottle and fill with liquid soap.

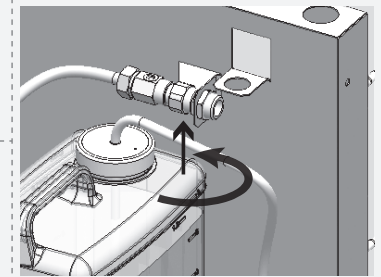

2

Place the cover back and screw it closed, making sure the hose extends to the bottom of the soap bottle.

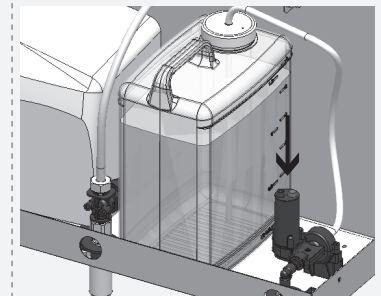

3

Press the refill button located on the top of the pump assembly until soap starts coming out of the soap dispenser spout. This operation can also be done using the soap dispenser remote control Refill function.

MAINTENANCE

FAUCET MAINTENANCE

Filter Cleaning Instructions

This faucet is provided with a stainless steel filter preventing foreign particles from entering the lines. It is recommended to clean the filters every six (6) months. If the water flow has decreased, this may be because the filter is clogged. The filter can be cleaned as follows:

1. Shut off the water shut-off valve.
2. Disassemble the faucet and remove the filter located between the solenoid housing and the flexible pipe.
3. Wash the filter under running water.
4. Reassemble the parts.
5. Make sure that there is no water leakage.

Solenoid Valve Servicing

The solenoid valve diaphragm requires periodic cleaning every six (6) months. Remove the diaphragm from the solenoid valve and examine it for dirt. In case it is dirty or clogged, wash it under running water and reassemble it.

Do not attempt to dismantle the solenoid valve if you are unfamiliar with electronic solenoid valves.

CARE AND CLEANING OF CHROME AND SPECIAL FINISHES

(Applies to faucet and soap dispenser)

DO NOT use steel wool or cleansing agents containing alcohol, acid, abrasives, or the like. Use of any prohibited cleaning or maintenance products or substances could damage the surface of the faucet/soap dispenser.

For surface cleaning use ONLY soap and water, then wipe dry with a clean cloth or towel.

When cleaning bathroom tiles, the faucet/soap dispenser should be protected from any splattering of harsh cleansers.

MAINTENANCE

THERMOSTATIC MIXING VALVE MAINTENANCE

Filter Cleaning Instructions

The mixing valve is provided with two stainless steel filters preventing foreign particles from entering the lines. If the water flow has decreased, this may be because the filters are clogged. The filters can be cleaned as follows:

1. Shut off the water and the shut-off valve.
2. Disconnect the water pipes.
3. Remove the filters and wash them under running water.
4. Reassemble the parts.
5. Reconnect the water pipes and restore the incoming water supply.
6. Make sure that there is no water leakage.

SOAP DISPENSER MAINTENANCE

Disassembly of the soap pipe from the pump

The soap pipe can be disconnected from the soap pump by a simple slide & pull action. The sliding ring of the quick connection fixation nipple on the pump should be pulled down. It releases the open end of the soap pipe which can then be easily pulled out.

SPARE PARTS LIST

12V TRANSFORMER	06522081
FAUCET	
SEALS AND SCREWS KIT	07210171
10-PACK SENSOR KIT	07220341
8-PACK SOLENOID AND HOUSING KIT	07221103
10-PACK SOLENOID KIT	07232000
DIAPHRAGM	04500001
SOAP DISPENSER	
10-PACK SENSOR KIT	07220317
6L SOAP TANK	07100023
SOAP DISPENSER PUMP ASSEMBLY	07222012
SOAP DISPENSER SPOUT ASSEMBLY	07271023

REMOTE CONTROL FUNCTIONS - FAUCET



ADJUSTING THE SETTINGS WITH THE REMOTE CONTROL

If necessary, the sensor settings can be adjusted as follows:

Shut off the water supply. In order to adjust the sensor with the remote control, hold the remote control straight in front of the sensor in a distance of about 6-8" (15-20cm).

Choose the function you want to adjust by pressing once on one of the function buttons. After pressing once on a specific function button, a quick flashing of the red light at the front of the sensor will occur. At this stage, you can change the setting by pressing the (+) or the (-) buttons, every push will increase or decrease one level. After finishing the adjustment, turn the water supply back on.

REMOTE CONTROL FUNCTIONS - FAUCET



DETECTION RANGE: This faucet was supplied with a self adjusting sensor. The ideal detection range for the specific location will be set automatically. Only if necessary, use the remote control to adjust the sensor range as follows:

Press the **RANGE** button. Wait until a quick flashing of the red light in the sensor eye is perceived. Then, press + to increase the range and – to reduce it. Every push will increase or decrease one level.

NOTE: Once you have changed the detection range with the remote control, the distance will be remembered by the sensor, even if the power source is disconnected. To get back to the self adjustment mode, use the **ADJ** button only.



ENTRANCE TO THE SELF ADJUSTMENT MODE: Check that no objects are in front of the sensor. Press the **ADJ** button. Once a quick flashing of the red light of the sensor eye is perceived, remove your hand holding the remote control and move away from the sensor area. The ideal sensor range for the specific location will be set automatically. Once the self adjustment has taken place, the solenoid valve will be opened and closed for 1 second as an indication that the ideal sensor range was set and the product is ready for use.



SECURITY TIME: The Security time, prevents continuous running of water due to reflections or vandalism. By default, if the sensor is covered for more than 90 seconds the water flow will shut automatically. To resume regular operation any obstruction must be removed.

Press the **SEC** button. Wait until a quick flashing of the red light in the sensor eye is perceived. Then, press + to increase the security time and – to reduce it.



DELAY IN TIME: It is recommended to change the delay in time for flush valves for urinals or toilets only. If required, the delay in time can also be modified in faucets as follows:

Press the **IN** button. Wait until a quick flashing of the red light in the sensor eye is perceived. Then, press + to increase the delay in time and – to reduce it.

REMOTE CONTROL FUNCTIONS - FAUCET



DELAY OUT TIME: This button allows modifying the water flow time after the user removes his hands from the faucet. A delay out time close to 0 will save more water. An increased delay out time will make the user experience more comfortable. If required, the delay out time can be modified as follows:

Press the **OUT** button. Wait until a quick flashing of the red light in the sensor eye is perceived. Then, press + to increase the delay out time and – to reduce it.



24 HOUR HYGIENE FLUSH: If you have a compatible model with a 24 hours hygiene flush it is possible to enable and disable it. To activate the hygiene flush, press the clock button. Wait until a quick flashing of the red light in the sensor eye is perceived. Then press + to activate the hygiene flush or – to deactivate it.



TEMPORARY OFF FUNCTION: This function is ideal to perform any kind of activity in front of the sensor without operating the system (for example, cleaning). The faucet will remain shut for 1 minute when this button is pressed once. To cancel this function and to return to normal operation press the On/Off button again or wait 1 minute.



RESET BUTTON: This function restores all the factory settings except for the sensor range. If required, press the Reset button and without releasing it, press the + button once.

NOTE: To enter the self adjusting mode, use the **ADJ** button. To change the sensor range, use the **RANGE** button.

REMOTE CONTROL FUNCTIONS - SOAP DISPENSER

If available, the soap dispenser remote control can adjust the dispenser's settings. To use the remote control hold it in front of the sensor at a distance of 10-15cm (4-6").

Attention: The remote control will not operate out of the recommended range (too close or too far).

The remote control can be used to adjust the following functions:

1-SOAP QUANTITY

The 1-4 drop keys allow the user to choose the desired soap quantity.

① 0.7 to 0.9cc ② 1.2 to 1.6 cc ③ 1.6 to 1.9 cc ④ 2.1 to 2.3 cc *

Indication: continuous blinking of the light in the sensor eye.

2-ADJ

This function resets the sensor back to factory settings.

Indication: 2 blinks of the light in the sensor eye.

3-TEMPORARY OFF FUNCTION

This function temporarily disables the dispenser. Use this function to perform maintenance in front of the sensor without activating the system (for example: cleaning). The soap dispenser will shut off for one minute after this button is pressed once.

To return to normal operation before the minute is over, press the On/Off button again.

Indication: OFF – 2 fast blinks, ON – 4 fast blinks

4-FILL THE SOAP TANK

Once the soap tank has been filled \refilled, press the FILL button. The pump will run for one minute, priming the piping with soap. Once soap begins dispensing from the spout, priming is complete. Press the FILL button again to stop the priming before the minute is over.

Indication: continuous solid light in the sensor eye.



LIMITED WARRANTY

Y. Stern Engineering Ltd. warrants that its electronic faucets, soap dispensers, air dryers, flush valves and controls will be free of defects in material and workmanship during normal use for two years from the date the product is purchased.

If a defect is found in normal use, Y. Stern Engineering Ltd. will, at its discretion, repair, provide a replacement part or product, or make appropriate adjustments. Damage caused by accident, misuse, or abuse is not covered by this warranty. Improper care and cleaning will void the warranty. Proof of purchase (original sales receipt) must be provided to Stern Engineering Ltd. with all warranty claims.

Stern Engineering Ltd is not responsible for labor charges, installation, or other incidental or consequential costs other than those noted above. In no event shall the liability of Stern Engineering Ltd. exceed the purchase price of the shower, valve or control.

If you believe that you have a warranty claim, contact your Stern Distributor, Dealer or Plumbing Contractor. Please be sure to provide all pertinent information regarding your claim, including a complete description of the problem, the product, model number, the date the product was purchased, from whom the product was purchased and the installation date. Also include your original invoice.

Y. STERN ENGINEERING AND/OR SELLER DISCLAIM ANY LIABILITY FOR SPECIAL, INCIDENTAL OR CONSEQUENTIAL DAMAGES. This warranty excludes product damage due to installation error, incorrect maintenance, wear and tear, battery, water composition, product abuse, or product misuse, whether performed by a contractor, service company, or the consumer. This warranty does not cover product damage caused by the following:

- Incorrect installation, inversions of supply pipes.
- Pressures or temperatures exceeding recommended limits.
- Improper manipulation, tampering, bad or lapsed maintenance.
- Foreign bodies, dirt or scale introduced by the water supply.

TROUBLESHOOTING - FAUCET

SOLUTION	CAUSE	INDICATOR	PROBLEM
No water coming out of the faucet.	Red light in the sensor does not flash (once) when user's hands are within the sensor's range.	Range is too short.	Increase the range.
		Range is too long.	Decrease the range.
		Unit is in "Security Mode": If the sensor is covered for more than 90 sec. the faucet will automatically shut off water flow.	To return to normal operating mode remove any blockage.
	Red light in the sensor flashes once when user's hands are within the sensor's range.	Sensor is picking up reflections from the washbasin or another object.	Eliminate cause of reflection.
		Debris or scale in solenoid.	Unscrew the solenoid, pull out the plunger and the spring from the solenoid and clean them. Use a scale remover material if needed. When replacing the plunger, please make sure that the spring is in vertical position.
		The central orifice in the diaphragm is plugged or the diaphragm is torn.	Clean the orifice or replace diaphragm.
Water flow from spout does not stop.	Red light in the sensor does not flash once when user's hands are within the sensor's range.	The water supply pressure is higher than 8 bar (116 PSI).	Reduce the supply water pressure or install a pressure reducer valve.
		The water supply pressure is under 8 bars and yet the pressure in the faucet's body is higher. This situation could be caused by a sudden increase in the water supply pressure that the backcheck prevents from dropping, even after water supply pressure drops under 8 bars.	Shut off water supply and unscrew one of the flexible pipes in order to reduce the pressure that is blocking the product.
Water flow diminished.	Sensor flashes once when user's hands are within the sensor's range.	Debris or scale in diaphragm.	Clean the orifice or replace diaphragm.
	Red light in the sensor does not flash once when user's hands are within the sensor's range.	Sensor is dirty or covered. (In this case, the water flow will stop anyway after 90 seconds due to the security time out). Sensor is picking up reflections from the washbasin or another object.	Clean or eliminate cause of interference. Decrease the range or eliminate cause of reflection.
		Filter or aerator is clogged.	Remove, clean re-install.

TROUBLESHOOTING - SOAP DISPENSER

SOLUTION	CAUSE	INDICATOR	PROBLEM
No soap coming out of the spout	Red light in the sensor flashes (once) and the motor is operating.	Soap has run low or completely out.	Refer to page 8 and refill the soap tank.
		The soap tank has been filled but soap has not reached the spout.	Press the refill button located at the bottom of the pump until soap starts to come out of the spout again.
		The connectors between the motor and the power source are not connected properly.	Connect the connectors properly so that the white o-ring is not visible.
	Red light in the sensor does not flash (once) when user's hands are within the sensor's range.	Sensor is picking up reflections from the washbasin or another object.	Eliminate cause of reflection.
		Connectors between the electronic unit and the pump assembly\transformer are disconnected or not properly connected.	Connect the electronic unit connectors to the pump assembly and transformer.
		Red light flashes (once) and the motor operates.	Soap solidification at the pipe. Fill the bottle with hot water at 50/60C and run the pump constantly.
Soap coming out of the spout does not stop		The black connectors between the pump assembly and soap dispenser are not connected properly.	Connect the connectors properly so that the white o-ring is not visible.

stern

STERN ENGINEERING LTD.

777 Passaic Avenue, Clifton NJ, 07012, USA
Tel: +1-973 773 8011 | Fax: +1-973-779-8768
Toll Free: 1-800-4364410
info@sternfaucets.com | sternusa@sternfaucets.com

